

# "French" True Divided Lite Doors

## "French" True Divided Lite Interior Doors

### "FRENCH" DOOR

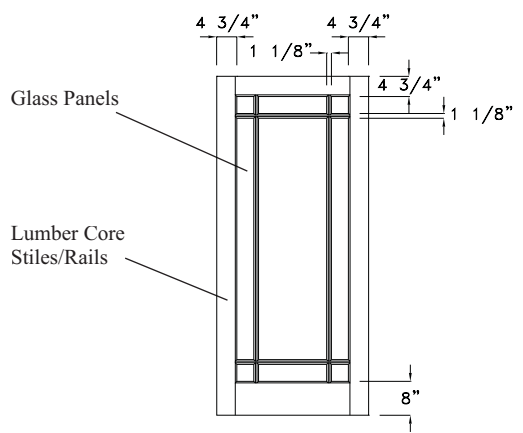

### OPTIONS AVAILABILITY

|                 | 1 3/8"                                                  | 1 3/4"                                                  |                                                             |
|-----------------|---------------------------------------------------------|---------------------------------------------------------|-------------------------------------------------------------|
| Woods           | *ALL                                                    | *ALL                                                    | *Character Oak/Cherry mullions will be standard Oak/Cherry. |
| Arch Options    | See individual French Door Style for arch availability  |                                                         |                                                             |
| Profile Options | Std. Hip<br>Dbl. Hip<br>Cove/Bead<br>Mission<br>Prairie | Std. Hip<br>Dbl. Hip<br>Cove/Bead<br>Mission<br>Prairie | See page 6 for more information on Profile Options.         |

**"FRENCH" TRUE DIVIDED LITE CONSTRUCTION:**  
 All "French" doors from Woodharbor are crafted as True Divided Lite. (Each lite of glass is an individual pane of glass secured with an applied glass stop molding.) When ordering "Factory-Finished" French doors, the entire door and glass stop molding are completely finished before the glass is installed. French doors are available in both 1 3/8" and 1 3/4" thicknesses.

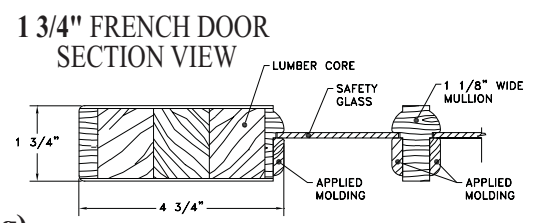
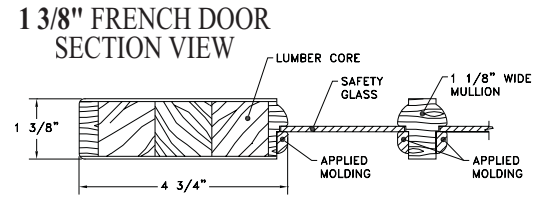

### FRENCH DOOR PROFILE OPTIONS (Glass Stop Molding)

French doors are available with a choice of "Profile Options" to match your raised or flat panel doors. A Profile Option designates the decorative profile of the "sticking" (inside edge of the stile/rail). A Profile Option must be specified for French door styles. Woodharbor recommends the "Cove and Bead" profile for French doors to coordinate with the Brittany door style.

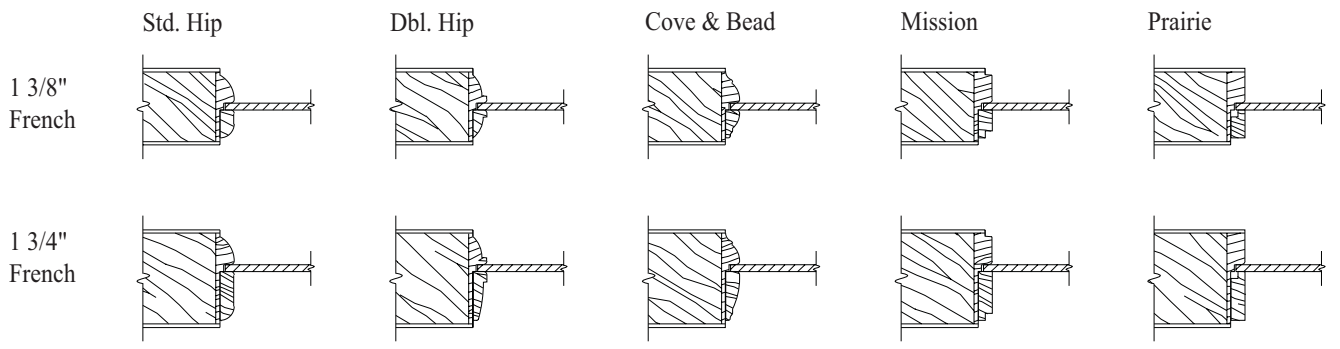

**Please Note:** Glass stop molding is designed specifically for 1/8" glass applications (for 1 3/8" and 1 3/4" doors). Although thicker glass applications can be accommodated, the molding "offset" will vary with the thickness of the glass/insert.

# "French" True Divided Lite Doors

## "French" True Divided Lite General Information

### ARCH OPTIONS

Some French doors are available with Arch options. See individual French door style for availability.

#### ROMAN ARCH (20 SERIES)

Doors specified with a Roman Arch are designated as a "20 Series" arch on the order form. The door has a square (flat) top and the top rail is carved with a Roman Arch. (i.e. F1-10, 20 Series) A "Continuous Arch" option is available for 20 Series arch double doors, by-pass and double pocket doors at no charge. Specify "Continuous Arch 20 Series" when placing your door order.

See page 31.

#### CATHEDRAL ARCH (30 SERIES)

Doors specified with a Cathedral Arch are designated as a "30 Series" arch on the order form. The door has a square (flat) top and the top rail is carved with a Cathedral Arch.

(i.e. F1-10, 30 Series)

#### ARCH TOP - EYEBROW (40 SERIES)

Doors specified with an Eyebrow Arch Top are designated as a "40 Series" arch on the order form. The door has an "eyebrow" radius at the top of the door and the top rail is carved with a Roman Arch. **Arch Top doors can be pre-hung in Solid Wood Jambs only.** Casing is available on a special-order/custom quote basis.

(i.e. F1-10, 40 Series)

Other Arch/Radius options are available on a custom quote basis.

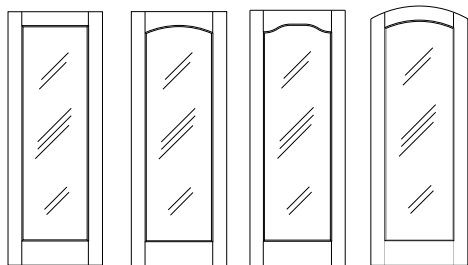

F1-10

F1-10  
(20 Series)

F1-10  
(30 Series)

F1-10  
(40 Series)

### Glass Information continued.....

#### "SAFETY" GLASS:

All glass supplied or installed by Woodharbor is a "safety" glass. Tempered glass is used for most applications. However, in applications where the glass is too small to temper, a clear laminated glass is used. (Lites smaller than 6" x 9" or 4" x 16" cannot be tempered - laminated safety glass is used for these applications.) For some door styles, clear tempered glass and clear laminated glass can be used within the same door - there is no visible difference between the two types of glass. (i.e. An F9-10 door style uses tempered glass for the larger lites of glass and laminated glass on the small 4"x4" corner lites.) White laminated glass is also available.

#### DECORATIVE GLASS INSERTS:

A variety of decorative insert options can be specified for an F1-10 Interior French Door. See pages 103-106 for Decorative Insert availability. ("Frosted" or true "Sandblasted" glass is not available (and is not recommended) because the texture of this glass will show fingerprints and marks from everyday use that cannot be removed. Woodharbor uses a "white laminated" glass instead.)

Despite the fact that certain door styles have glass limitations, very attractive designs can be created using a combination of clear glass and decorative glass. Contact Customer Service for specific options.

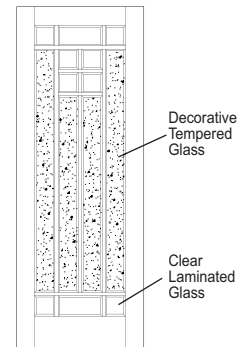

F14-10, 2/6 X 6/8

## GLASS INFORMATION

#### "OPEN FOR GLASS" OPTION:

French doors can be specified "Open for Glass" so that decorative glass inserts can be supplied and installed by the customer. Stop molding is sent loose for jobsite installation. Contact Customer Service for glass sizing information. Be sure to clearly specify "Open for Glass" on your order. (To specify "Open for Glass" on a paneled door (i.e. Charleston), contact Customer Service.)

Continued.....

# "French" True Divided Lite Doors

## "French" True Divided Lite General Information

### PLASTIC-WRAPPED GLASS FOR PROTECTION:

All glass is plastic wrapped from the glass manufacturer for protection during shipment, handling, installation and finishing. To remove plastic wrap after final installation of the door, carefully pull the wrap away from the glass while cutting. Use a new, sharp razor blade - Insert the blade under the edge of the stop molding and carefully cut the plastic. Do not touch the glass with the cutting blade - Use caution when removing the plastic wrap to prevent scratching the glass. If glass is scratched or broken on-site, the applied molding can be carefully pried loose so that a new pane of glass can be installed. Contact Customer Service for more information.

**Tempered Glass:** Glass is cut to the required size and shape, heated to 1200° F and then rapidly cooled on both sides with blasts of air. Tempered glass is 4x stronger than regular glass and more resistant to impact and thermal stresses. When broken, tempered glass will break into small, square-edged granules rather than sharp shards. Each piece of Tempered Glass receives a small, inconspicuous tempered "logo" in a corner of the pane for building inspection purposes and according to building codes. *Tempered glass has minimum size limitations due to the tempering process.*

**Laminated Glass:** A thin, transparent vinyl layer is laminated between two sheets of glass and then bonded together with heat and pressure. When broken, laminated glass is held together by the vinyl layer to reduce risk of injury.

*Please Note: Glass stop molding is designed specifically for 1/8" glass applications (for 1 3/8" and 1 3/4" doors). Although thicker glass applications can be accommodated, the molding "offset" will vary with the thickness of the glass/insert.*

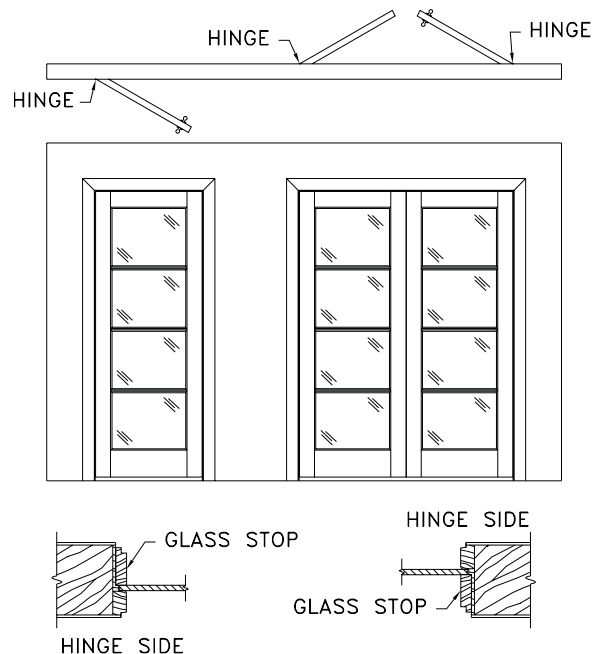
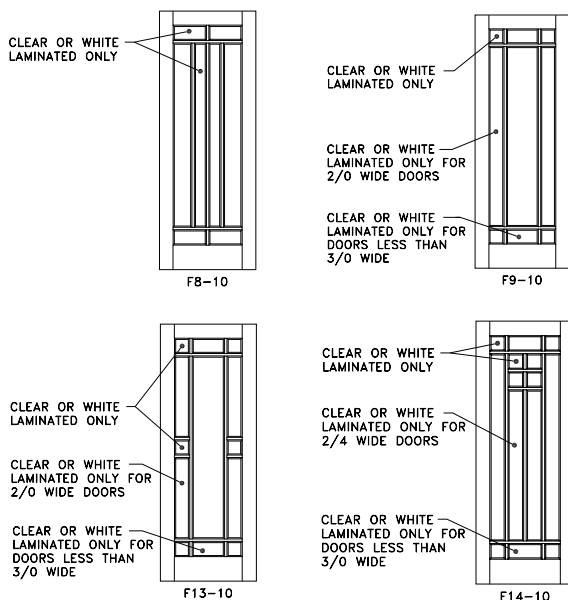
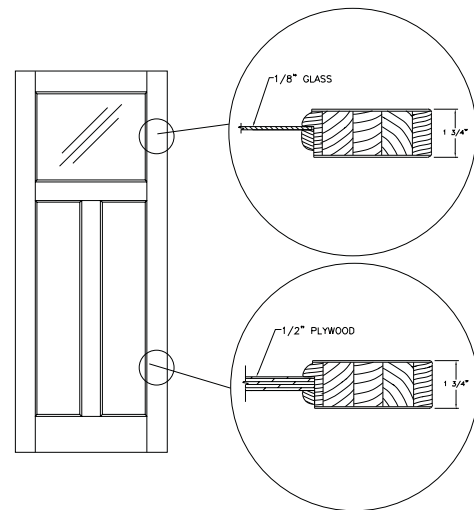

Some door styles cannot be specified with decorative tempered glass because the lites are too small to temper. Laminated glass is available for these applications in either clear or white laminated. Contact Customer Service for specific sizing and availability information.

♦ **Minimum lite size for Tempered Glass: 6" x 9" or 4" x 16".**

As a general rule, the following French door styles have lites of glass that are too small to be tempered and/or bevelled: F8-10, F9-10, F13-10, F14-10.

The smaller lites of glass are available with clear or white laminated glass only.

The larger lites depend on the overall size of the door. Contact Customer Service for more information.

*This molding detail (offset) can be especially noticeable when combining panels and glass within a door (shown above top) or when the swing of a series of doors changes within a corridor or room (shown above).*

# "French" True Divided Lite Doors

## F1-10 - INTERIOR DOORS

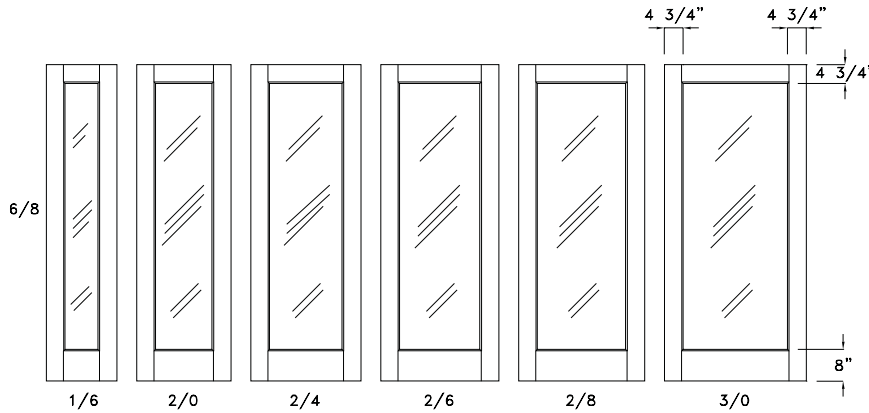

F1-10 is available in all arch options (i.e. 20 Series).  
Cathedral Arch doors (30 Series) are not available in a 1/6 passage.  
A 3/0 Double uses two 1/6 doors, each with a half-arch.

*Clear safety glass is stocked for all standard sizes shown above.  
For custom size doors, additional lead time may apply due to the non-stock glass sizes. Decorative glass, beveled glass, and arched glass may require additional lead time.*

### F1-10 Bi-Fold

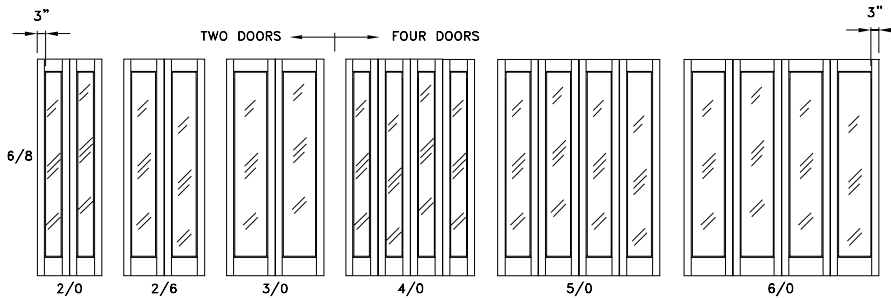

*Always refer to the Jamb Availability chart on page 11 for available jamb options.*

**For Finish, Hinge, Door Profile and Arch Option availabilities, see the General Information section.**

#### STANDARD SIZES (Nominal)

Door Heights: 6/8, 7/0, 8/0  
Passage & Pocket Doors: 1/6, 2/0, 2/4, 2/6, 2/8, 3/0  
Double & Pocket Doors: 3/0, 4/0, 4/8, 5/0, 5/4, 6/0  
Bi-Fold Doors: 2/0, 2/6, 3/0, 4/0, 5/0, 6/0  
*Custom sizes available upon request.*

# "French" True Divided Lite Doors

## F4-10 - INTERIOR DOORS

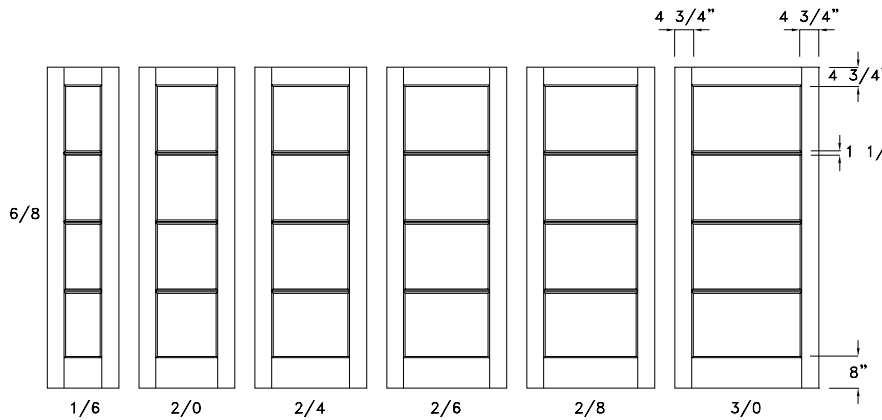

F4-10 is available in all arch options (i.e. 20 Series).

Cathedral Arch doors (30 Series) are not available in a 1/6 passage.  
A 3/0 Double uses two 1/6 doors, each with a half-arch.

*Clear safety glass is stocked for all standard sizes shown above.  
For custom size doors, additional lead time may apply due to the non-stock glass sizes. Decorative glass, beveled glass, and arched glass may require additional lead time.*

### F4-10 Bi-Fold

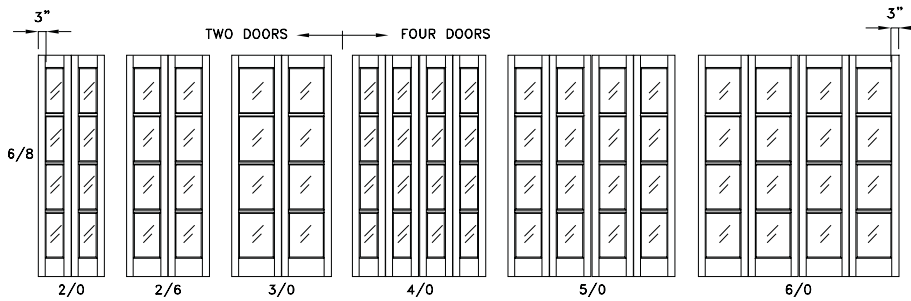

*Always refer to the Jamb Availability chart on page 11 for available jamb options.*

**For Finish, Hinge, Door Profile and Arch Option availabilities, see the General Information section.**

**STANDARD SIZES (Nominal)**  
 Door Heights: 6/8, 7/0, 8/0  
 Passage & Pocket Doors: 1/6, 2/0, 2/4, 2/6, 2/8, 3/0  
 Double & Pocket Doors: 3/0, 4/0, 4/8, 5/0, 5/4, 6/0  
 Bi-Fold Doors: 2/0, 2/6, 3/0, 4/0, 5/0, 6/0  
*Custom sizes available upon request.*

**FOR MORE FRENCH DOOR STYLES, SEE PAGES 90-98.**



# "French" True Divided Lite Doors

## F8-10 - INTERIOR DOORS

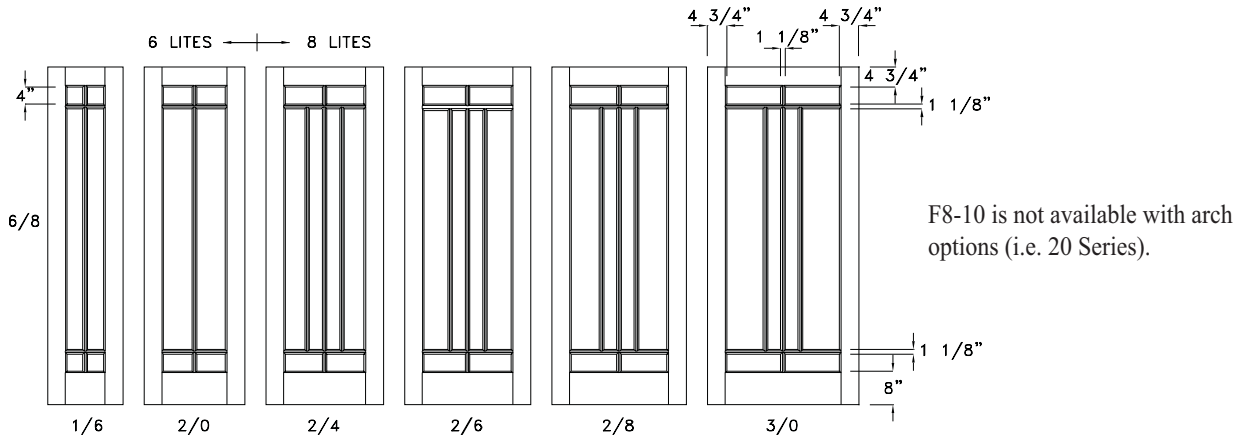

Any F8-10 door under 2/2 in width will have 6 lites instead of 8 lites.

Clear safety glass is stocked for all standard sizes shown above.

For custom size doors, additional lead time may apply due to the non-stock glass sizes. Decorative glass, beveled glass, and arched glass may require additional lead time.

### DECORATIVE GLASS

F8-10 doors have limitations on decorative glass availability due to the size of the lites. See pages 85-87 for more information and contact Customer Service if additional information is needed. Additional lead time will apply.

Always refer to the Jamb Availability chart on page 11 for available jamb options.

**For Finish, Hinge, Door Profile and Arch Option availabilities, see the General Information section.**

### STANDARD SIZES (Nominal)

Door Heights: 6/8, 7/0, 8/0  
 Passage & Pocket Doors: 1/6, 2/0, 2/4, 2/6, 2/8, 3/0  
 Double & Pocket Doors: 3/0, 4/0, 4/8, 5/0, 5/4, 6/0  
 Custom sizes available upon request.

# "French" True Divided Lite Doors

## F8-12 - INTERIOR DOORS

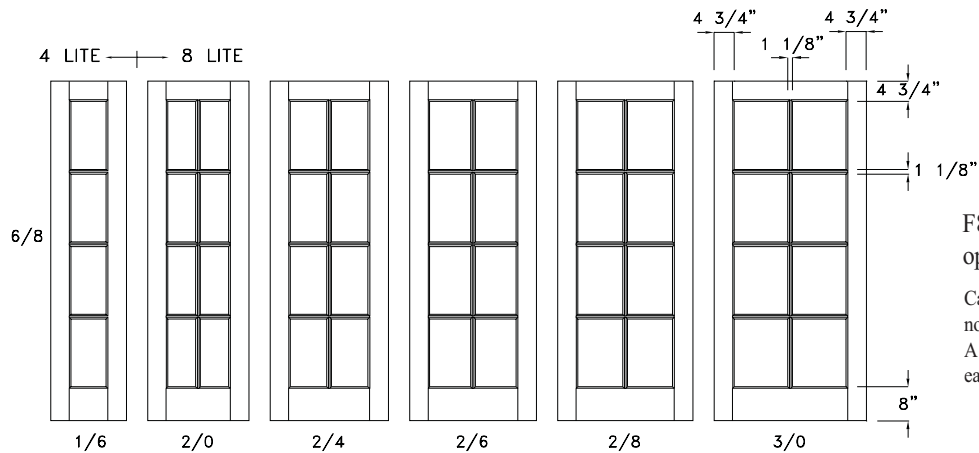

F8-12 is available in all arch options (i.e. 20 Series).

Cathedral Arch doors (30 Series) are not available in a 1/6 passage.  
A 3/0 Double uses two 1/6 doors, each with a half-arch.

Any F8-12 door under 1/8 in width will have 4 lites instead of 8 lites.

Clear safety glass is stocked for all standard sizes shown above.  
For custom size doors, additional lead time may apply due to the non-stock glass sizes. Decorative glass, beveled glass, and arched glass may require additional lead time.

### F8-12 Bi-Fold

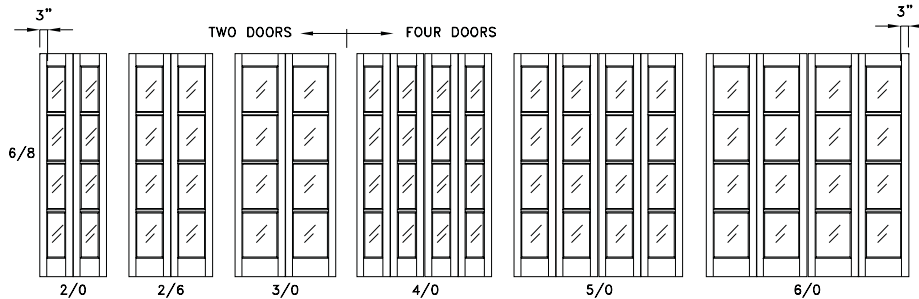

Always refer to the Jamb Availability chart on page 11 for available jamb options.

**For Finish, Hinge, Door Profile and Arch Option availabilities, see the General Information section.**

| STANDARD SIZES (Nominal)                    |                              |
|---------------------------------------------|------------------------------|
| Door Heights:                               | 6/8, 7/0, 8/0                |
| Passage & Pocket Doors:                     | 1/6, 2/0, 2/4, 2/6, 2/8, 3/0 |
| Double & Pocket Doors:                      | 3/0, 4/0, 4/8, 5/0, 5/4, 6/0 |
| Bi-Fold Doors:                              | 2/0, 2/6, 3/0, 4/0, 5/0, 6/0 |
| <i>Custom sizes available upon request.</i> |                              |

FOR MORE FRENCH DOOR STYLES, SEE PAGES 88-89 & 92-98.

# "French" True Divided Lite Doors

## F9-10 - INTERIOR DOORS

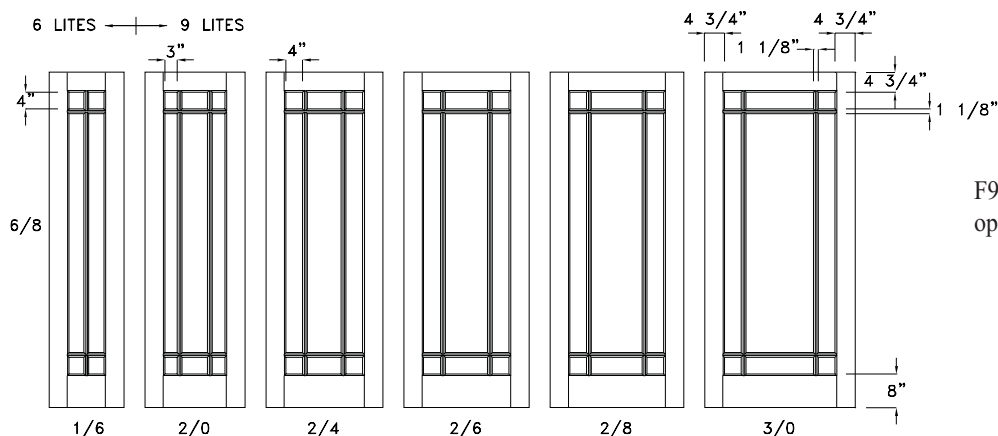

F9-10 is not available in arch options (i.e. 20 Series).

Any F9-10 door under 1/10 in width will have 6 lites instead of 9 lites.

Clear safety glass is stocked for all standard sizes shown above.

For custom size doors, additional lead time may apply due to the non-stock glass sizes. Decorative glass, beveled glass, and arched glass may require additional lead time.

### DECORATIVE GLASS

F8-10 doors have limitations on decorative glass availability due to the size of the lites. See pages 85-87 for more information and contact Customer Service if additional information is needed. Additional lead time will apply.

Always refer to the Jamb Availability chart on page 11 for available jamb options.

**For Finish, Hinge, Door Profile and Arch Option availabilities, see the General Information section.**

### STANDARD SIZES (Nominal)

Door Heights: 6/8, 7/0, 8/0  
 Passage & Pocket Doors: 1/6, 2/0, 2/4, 2/6, 2/8, 3/0  
 Double & Pocket Doors: 3/0, 4/0, 4/8, 5/0, 5/4, 6/0  
 Custom sizes available upon request.



# "French" True Divided Lite Doors

## F10-10 - INTERIOR DOORS

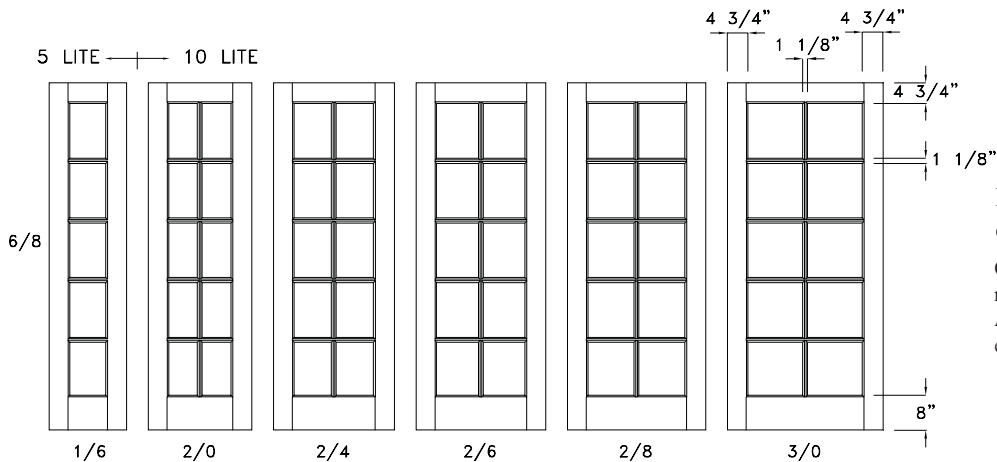

F10-10 is available in all arch options (i.e. 20 Series).

Cathedral Arch doors (30 Series) are not available in a 1/6 passage.

A 3/0 Double uses two 1/6 doors, each with a half-arch.

Any F10-10 door under 1/8 in width will have 5 lites instead of 10 lites.

Clear safety glass is stocked for all standard sizes shown above.

For custom size doors, additional lead time may apply due to the non-stock glass sizes. Decorative glass, beveled glass, and arched glass may require additional lead time.

### F10-10 Bi-Fold

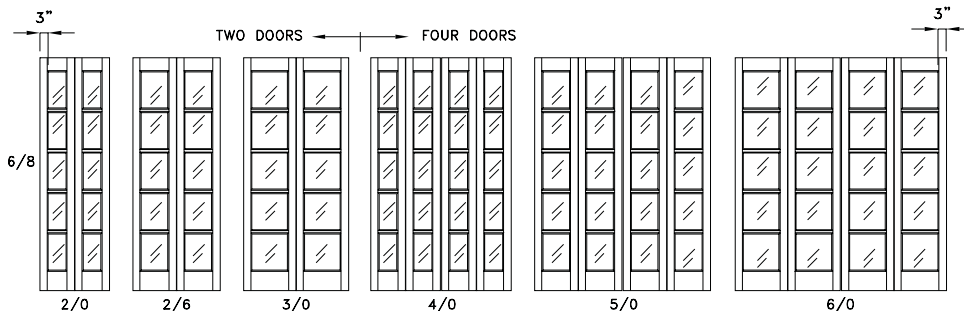

Always refer to the Jamb Availability chart on page 11 for available jamb options.

**For Finish, Hinge, Door Profile and Arch Option availabilities, see the General Information section.**

#### STANDARD SIZES (Nominal)

Door Heights: 6/8, 7/0, 8/0

Passage & Pocket Doors: 1/6, 2/0, 2/4, 2/6, 2/8, 3/0

Double & Pocket Doors: 3/0, 4/0, 4/8, 5/0, 5/4, 6/0

Bi-Fold Doors: 2/0, 2/6, 3/0, 4/0, 5/0, 6/0

Custom sizes available upon request.

FOR MORE FRENCH DOOR STYLES, SEE PAGES 88-91 & 94-98

# "French" True Divided Lite Doors

## F12-10 - INTERIOR DOORS (8/0 ONLY)

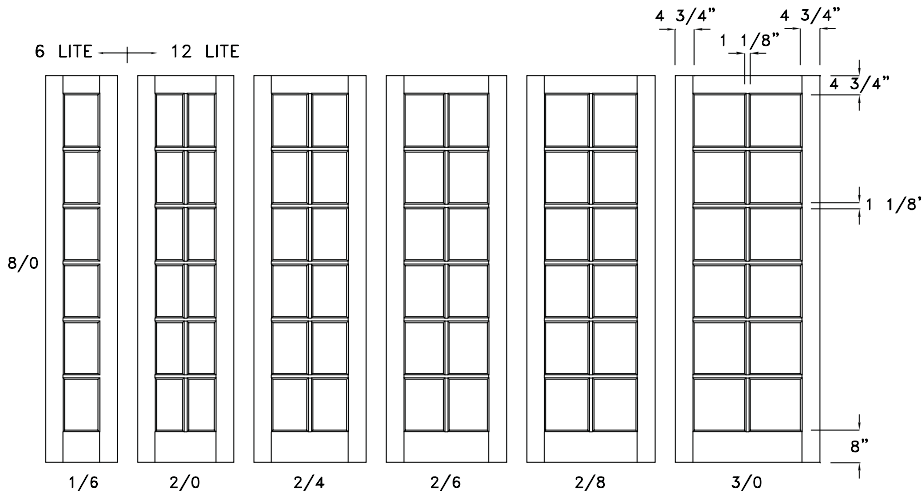

F12-10 is available in all arch options (i.e. 20 Series).

Cathedral Arch doors (30 Series) are not available in a 1/6 passage.  
A 3/0 Double uses two 1/6 doors, each with a half-arch.

Any F12-10 door under 1/8 in width will have 6 lites instead of 12 lites.

Clear safety glass is stocked for all standard sizes shown above.

For custom size doors, additional lead time may apply due to the non-stock glass sizes. Decorative glass, beveled glass, and arched glass may require additional lead time.

### F12-10 Bi-Fold

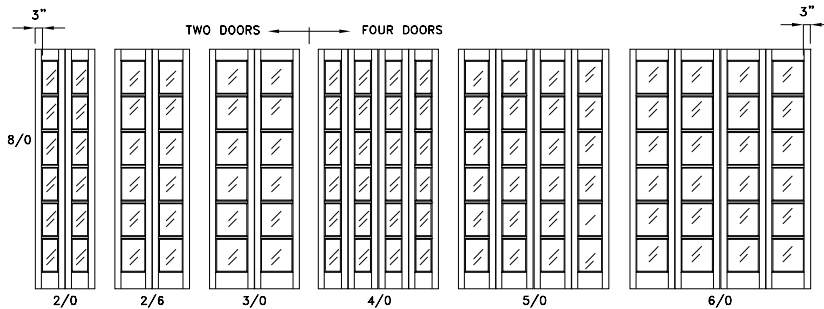

**The F12-10 is only available in 8/0 height with a Solid Wood Jamb.**

For Solid Wood Jambs see page 11.

For Finish, Hinge, Door Profile and Arch Option availabilities, see the General Information section.

#### STANDARD SIZES (Nominal)

Door Heights: 8/0

Passage & Pocket Doors: 1/6, 2/0, 2/4, 2/6, 2/8, 3/0

Double & Pocket Doors: 3/0, 4/0, 4/8, 5/0, 5/4, 6/0

Bi-Fold Doors: 2/0, 2/6, 3/0, 4/0, 5/0, 6/0

Custom sizes available upon request.

# "French" True Divided Lite Doors

## F13-10 - INTERIOR DOORS

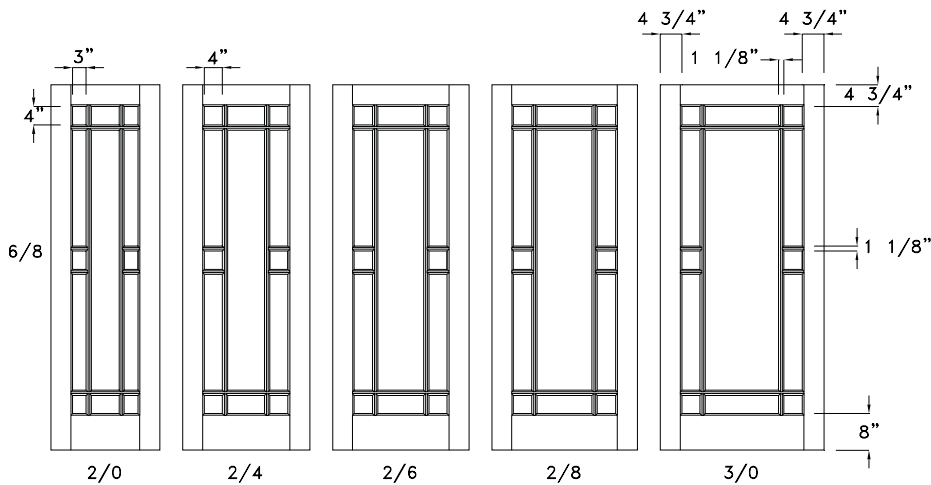

F13-10 is not available in arch options (i.e. 20 Series).

Clear safety glass is stocked for all standard sizes shown above.  
 For custom size doors, additional lead time may apply due to the non-stock glass sizes. Decorative glass, beveled glass, and arched glass may require additional lead time.

### DECORATIVE GLASS

F8-10 doors have limitations on decorative glass availability due to the size of the lites. See pages 85-87 for more information and contact Customer Service if additional information is needed. Additional lead time will apply.

Always refer to the Jamb Availability chart on page 11 for available jamb options.

**For Finish, Hinge, Door Profile and Arch Option availabilities, see the General Information section.**

| STANDARD SIZES (Nominal)                    |                              |
|---------------------------------------------|------------------------------|
| Door Heights:                               | 6/8, 7/0, 8/0                |
| Passage & Pocket Doors:                     | 1/6, 2/0, 2/4, 2/6, 2/8, 3/0 |
| Double & Pocket Doors:                      | 3/0, 4/0, 4/8, 5/0, 5/4, 6/0 |
| Bi-Fold Doors:                              | 2/0, 2/6, 3/0, 4/0, 5/0, 6/0 |
| <i>Custom sizes available upon request.</i> |                              |

FOR MORE FRENCH DOOR STYLES, SEE PAGES 88-93 & 96-98.

# "French" True Divided Lite Doors

## F14-10 - INTERIOR DOORS

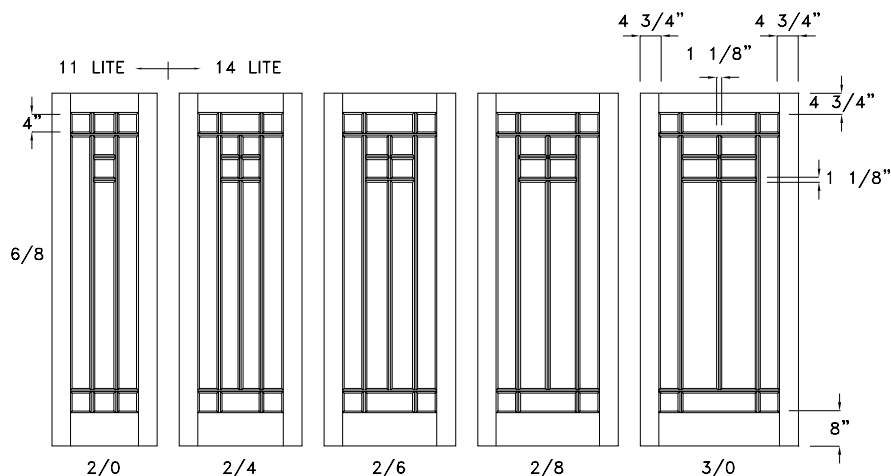

F14-10 is not available in arch options (i.e. 20 Series).

Any F14-10 door under 2/4 in width will have 11 lites instead of 14 lites.

Clear safety glass is stocked for all standard sizes shown above.

For custom size doors, additional lead time may apply due to the non-stock glass sizes. Decorative glass, beveled glass, and arched glass may require additional lead time.

### DECORATIVE GLASS

F8-10 doors have limitations on decorative glass availability due to the size of the lites. See pages 85-87 for more information and contact Customer Service if additional information is needed. Additional lead time will apply.

Always refer to the Jamb Availability chart on page 11 for available jamb options.

**For Finish, Hinge, Door Profile and Arch Option availabilities, see the General Information section.**

### STANDARD SIZES (Nominal)

Door Heights: 6/8, 7/0, 8/0

Passage & Pocket Doors: 2/0, 2/4, 2/6, 2/8, 3/0

Double & Pocket Doors: 4/0, 4/8, 5/0, 5/4, 6/0

Custom sizes available upon request.

# "French" True Divided Lite Doors

## F15-10 - INTERIOR DOORS

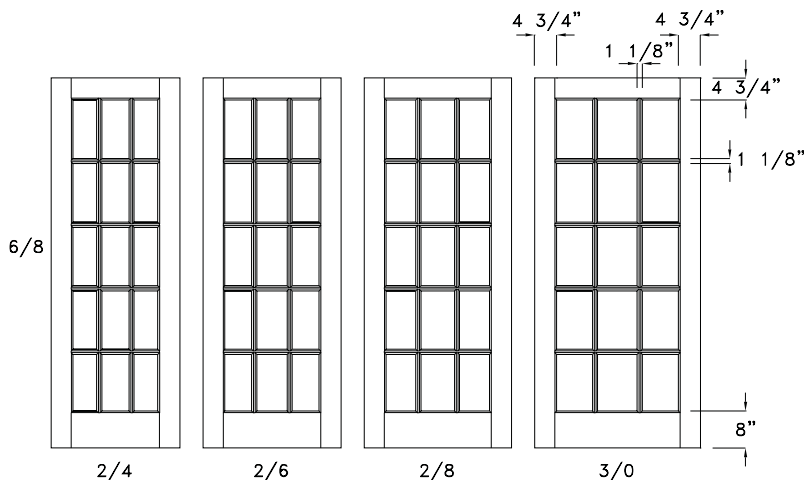

F15-10 is available in all arch options (i.e. 20 Series).

For smaller sizes, order an F10-10.

Clear safety glass is stocked for all standard sizes shown above.

For custom size doors, additional lead time may apply due to the non-stock glass sizes. Decorative glass, beveled glass, and arched glass may require additional lead time.

### F15-10 Bi-Fold

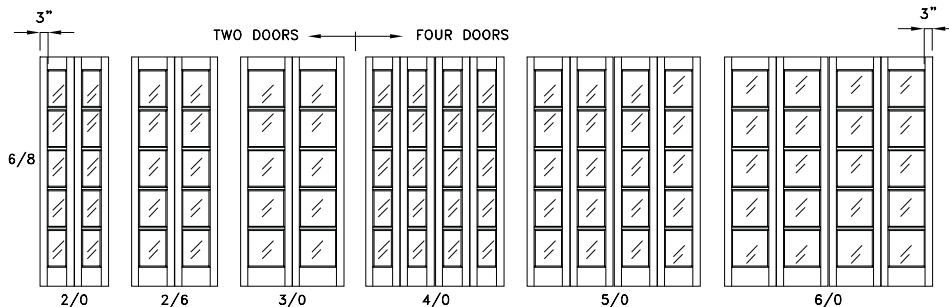

Always refer to the Jamb Availability chart on page 11 for available jamb options.

**For Finish, Hinge, Door Profile and Arch Option availabilities, see the General Information section.**

| STANDARD SIZES (Nominal)                    |                              |
|---------------------------------------------|------------------------------|
| Door Heights:                               | 6/8, 7/0, 8/0                |
| Passage & Pocket Doors:                     | 2/4, 2/6, 2/8, 3/0           |
| Double & Pocket Doors:                      | 4/8, 5/0, 5/4, 6/0           |
| Bi-Fold Doors:                              | 2/0, 2/6, 3/0, 4/0, 5/0, 6/0 |
| <i>Custom sizes available upon request.</i> |                              |

FOR MORE FRENCH DOOR STYLES, SEE PAGES 88-95 & 98.

# "French" True Divided Lite Doors

## F18-10 - INTERIOR DOORS (8/0 ONLY)

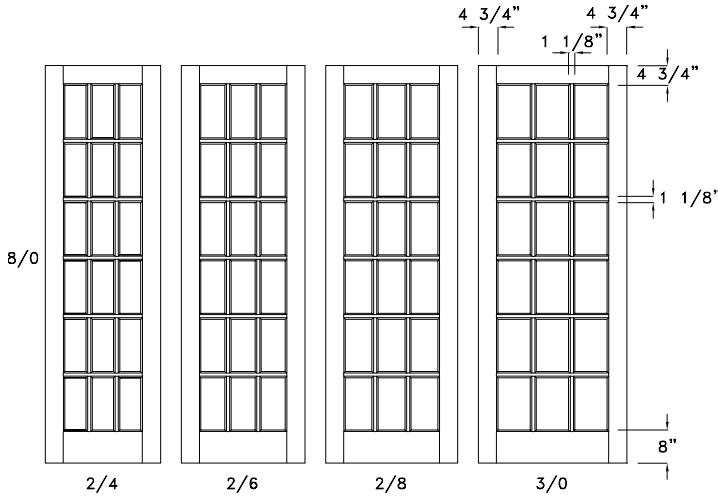

F18-10 is available in all arch options (i.e. 20 Series).

For smaller sizes, order an F10-10.

Clear safety glass is stocked for all standard sizes shown above. For custom size doors, additional lead time may apply due to the non-stock glass sizes. Decorative glass, beveled glass, and arched glass may require additional lead time.

### F18-10 Bi-Fold

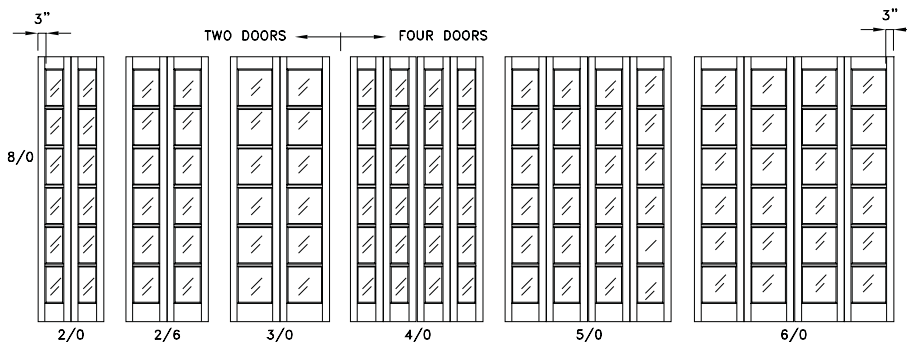

**The F18-10 is only available in 8/0 height with a Solid Wood Jamb.**

For Solid Wood Jambs see page 11.

For Finish, Hinge, Door Profile and Arch Option availabilities, see the General Information section.

| STANDARD SIZES (Nominal)                    |                              |
|---------------------------------------------|------------------------------|
| Door Heights:                               | 8/0                          |
| Passage & Pocket Doors:                     | 2/4, 2/6, 2/8, 3/0           |
| Double & Pocket Doors:                      | 4/8, 5/0, 5/4, 6/0           |
| Bi-Fold doors:                              | 2/0, 2/6, 3/0, 4/0, 5/0, 6/0 |
| <i>Custom sizes available upon request.</i> |                              |

FOR MORE FRENCH DOOR STYLES, SEE PAGES 88-97.